

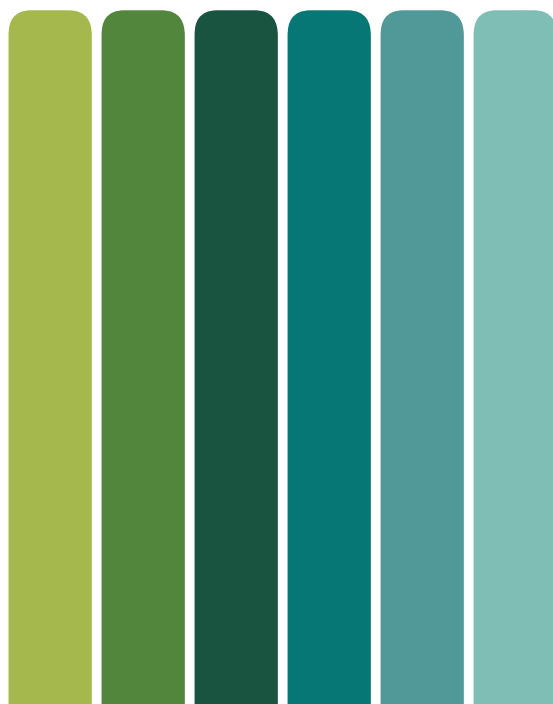

**HANDLEIDING  
TREKSHAKELAAR**



## MODELLEN

TR200T, TR200K





## 1. INHOUDSOPGAVE

1. Inhoudsopgave.....	2
2. Specificaties.....	2
3. Inhoud verpakking.....	3
4. Aansluitschema.....	2
5. Maatvoering trekschakelaar.....	3
6. Maatvoering montageplaat plafond.....	3

## 2. SPECIFICATIES

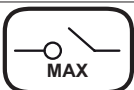
- Keuze uit een model met een kunststof rood/witte ketting of met een rood koord
- De lengte van de ketting en koord is 2 meter
- Geschikt voor wand- of plafondmontage
- Voorzien van maak- en verbreekcontact

		
400V AC 4A	IP66	-30° ~ +50°

## 3. INHOUD VERPAKKING

- Trekschakelaar
- Montageplaat voor plafondmontage (deze is reeds achter de trekschakelaar gemonteerd)
- Kabelwartel PG11
- Rood koord 2 meter (wordt los meegeleverd bij artikel TR200T)
- Rood/witte ketting 2 meter (wordt los meegeleverd bij artikel TR200K)

## 4. AANSLUITSCHEMA

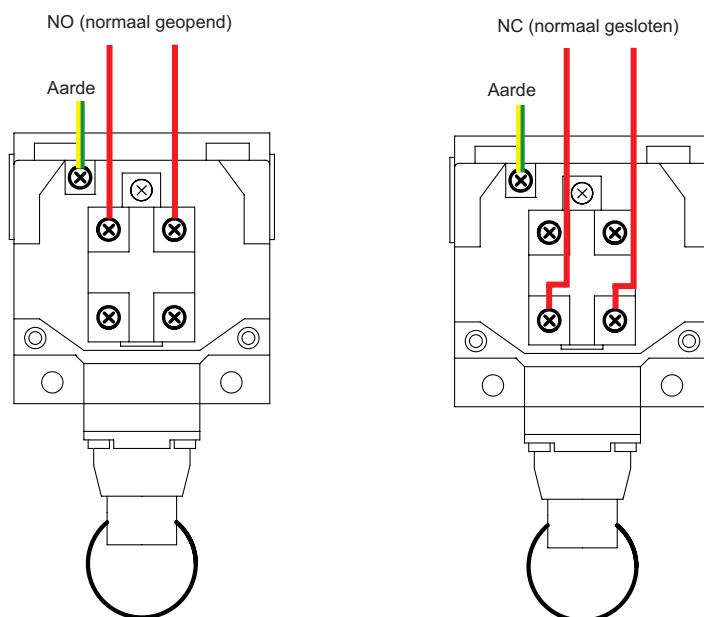

5. MAATVOERING TREKSCHAKELAAR

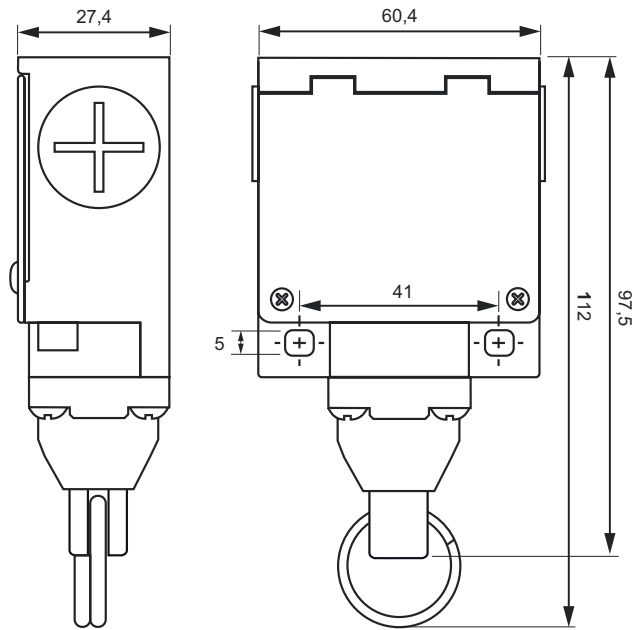

6. MAATVOERING MONTAGEPLAAT PLAFOND

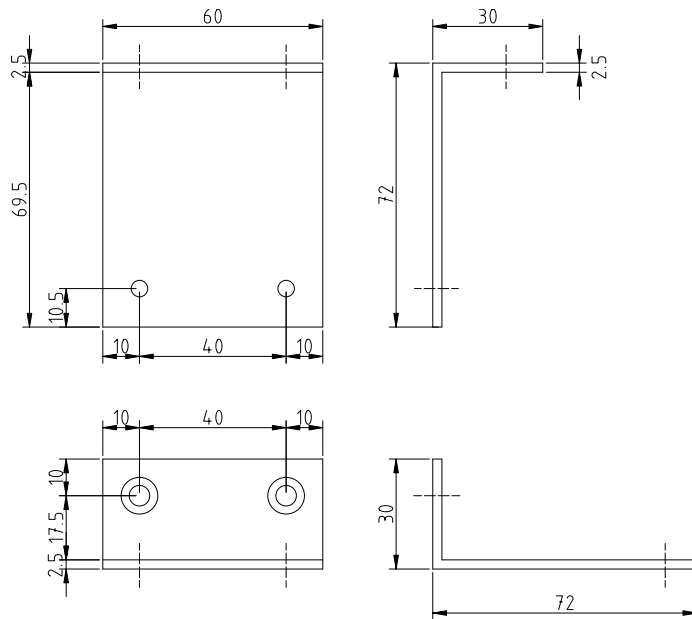

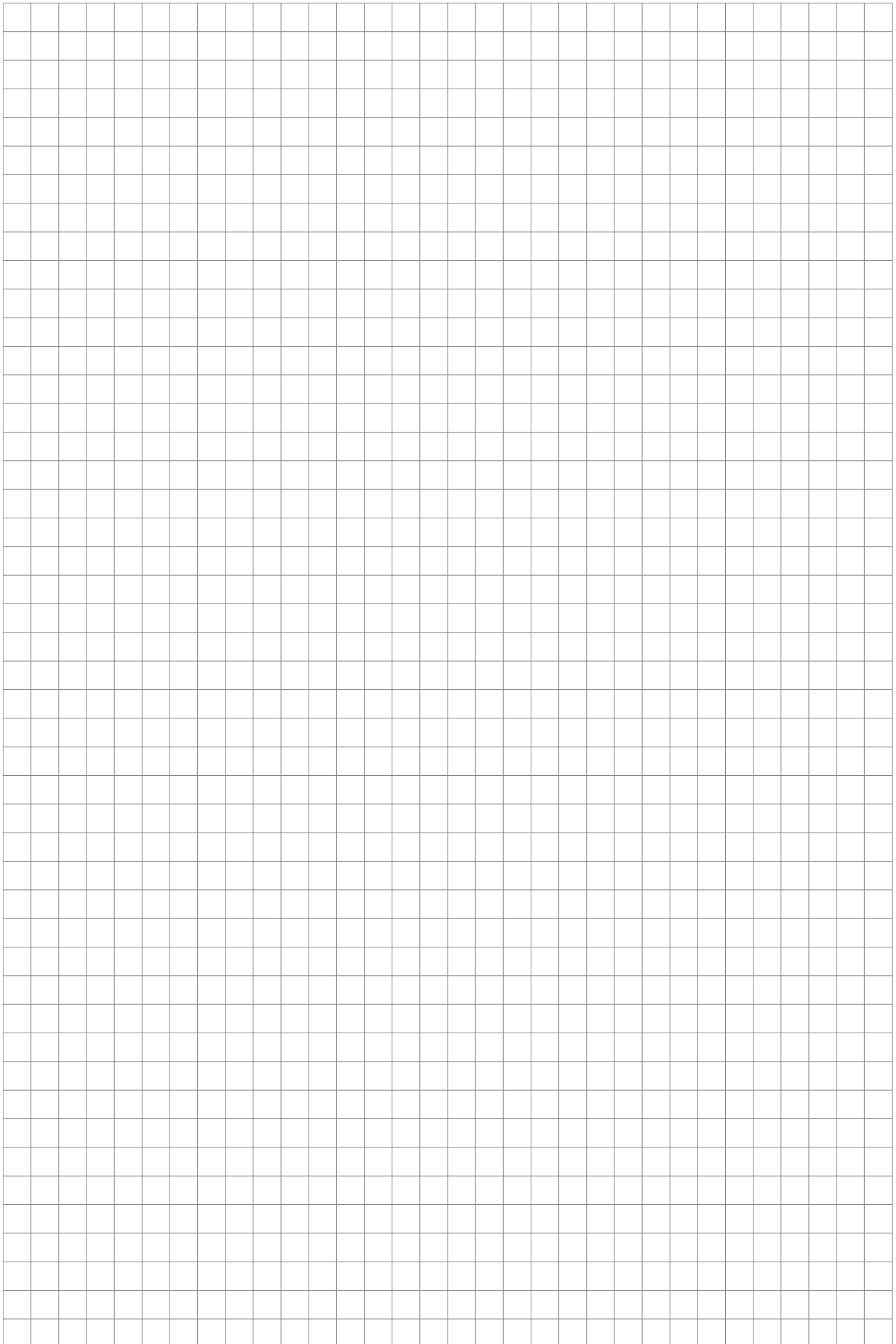

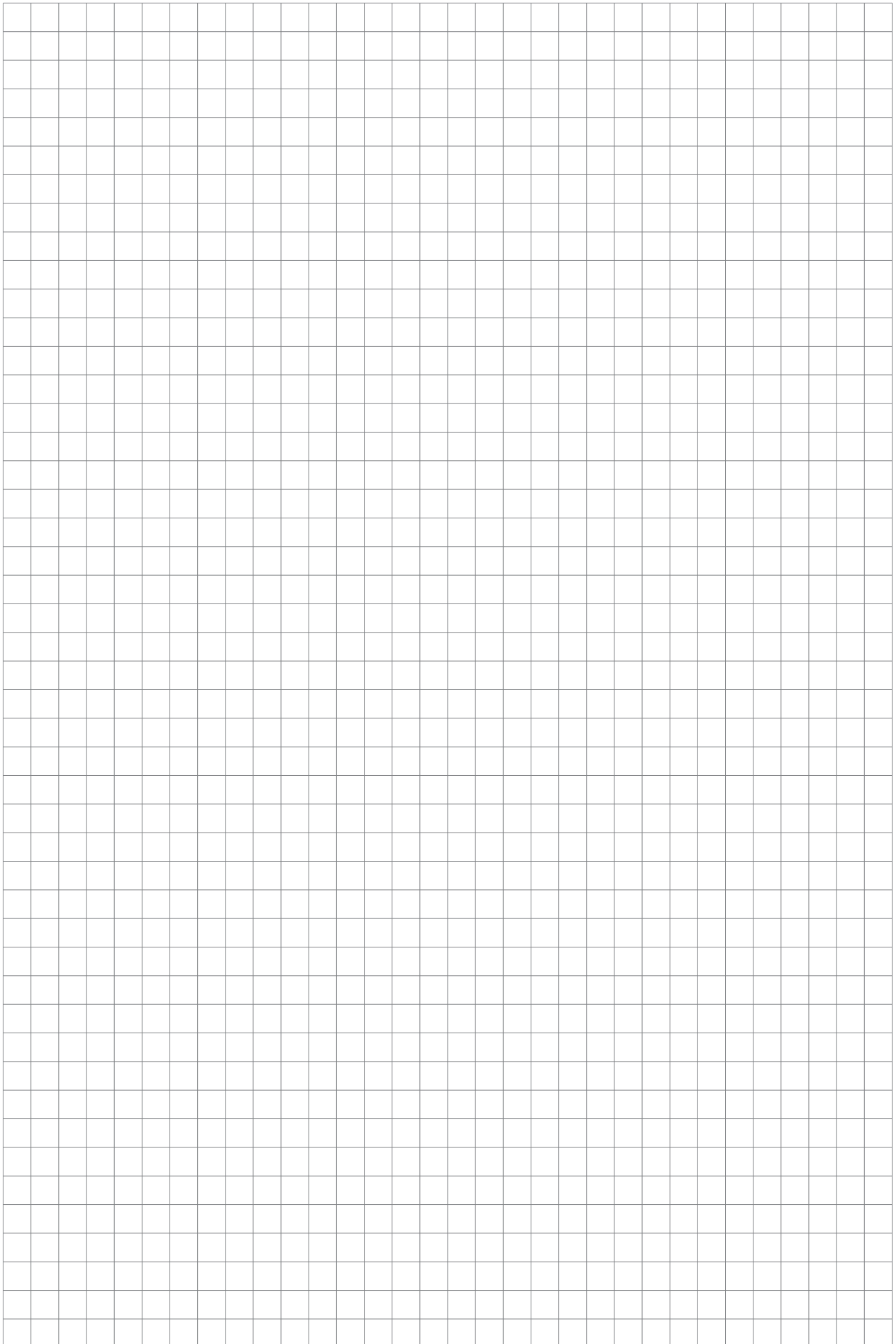

Maasland Groep B.V.  
De Hoogjens 51-55a  
4254 XV SLEEUWIJK  
Nederland  
T 088 500 2800  
info@maaslandgroep.nl  
www.maaslandgroep.nl



Maasland Hou Co., Ltd.  
Floor 6, Block E,  
Guanlan Town, Longhua,  
SHENZHEN  
China  
info@maaslandhou.com  
www.maaslandhou.com

Maasland Group Belgium B.V.  
Eedverbondkaai 242, bus 41  
9000 GENT  
België  
T +32 9 328 33 34  
info@maaslandgroup.be  
www.maaslandgroup.be

